

A

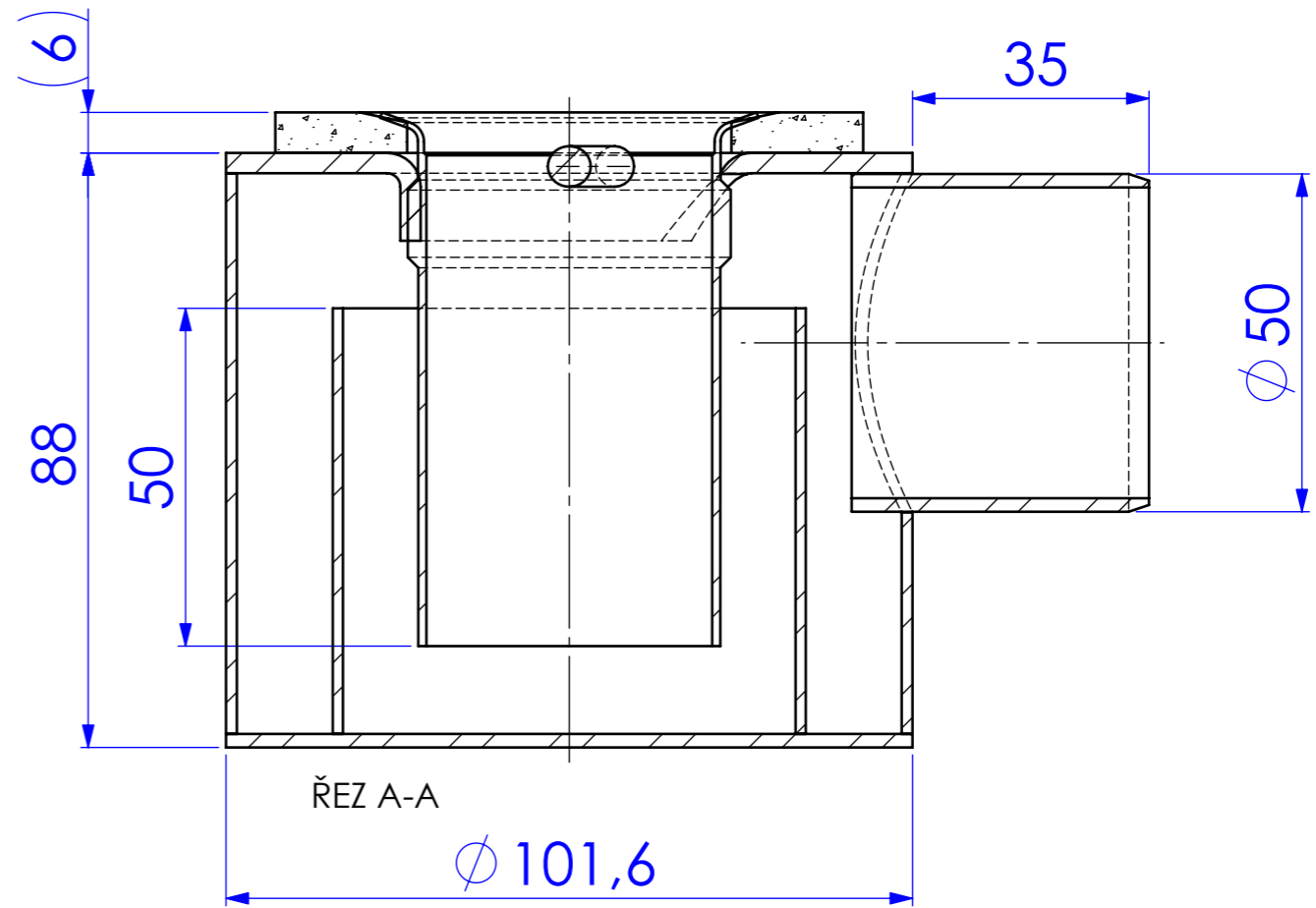

PN 50

Material: DIN 1.4301

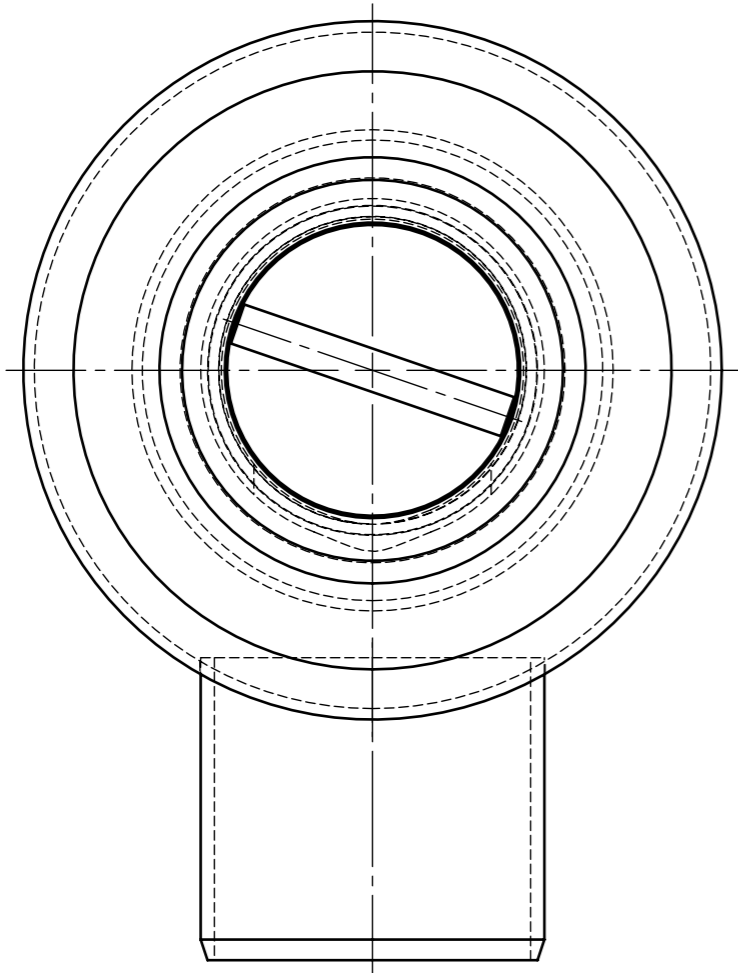